



User Guide

Konftel 60W Conference Unit

UK English

Conference phones for every situation





The Bluetooth® trademark and logos are owned by the Bluetooth SIG, Inc. and any use of such trademarks by Konftel is under license. Other trademarks and trade names belong to their respective owners.

OmniSound®





This product is equipped with OmniSound®, the crystal clear sound.



We, **Konftel AB** declare under our sole responsibility that our product **Konftel 60W** to which this declaration relates is in conformity with the appropriate standards EN 300 328, EN 301 489-17, EN 301 489-7 and EN 60950 following the provisions of Radio Equipment and Telecommunication Equipment directive **1999/5/EC** with requirements covering EMC directive **89/336/EEG** and Low Voltage directive **73/23/EEG**.

Umeå, May 2004

Peter Renkel, CEO Konftel AB

WARNING: To reduce the risk of fire or shock hazard, do not expose this product to rain or moisture.		
	CAUTION	
RISK OF ELECTRIC SHOCK DO NOT OPEN		
CAUTION: TO REDUCE THE RISK OF ELECTRICAL SHOCK, DO NOT REMOVE COVER OR BACK. NO USER-SERVICEABLE PARTS INSIDE. REFER SERVICING TO QUALIFIED PERSONNEL.		
	The lightning symbol is intended to alert you to the presence of uninsulated dangerous voltage within this product's enclosure that might be of sufficient magnitude to constitute a risk of electric shock. Do not open the product's case.	
	The exclamation symbol is intended to inform you that important operating and maintenance instructions are included in the literature accompanying this product.	

Description	2
Maintenance	3
Using Bluetooth	4
Connecting and settings	4
Answering a call	7
Making a call.....	7
During a call	8
Ending a call	9
After calls	9
Advanced functions	10
Using a system telephone	12
Connecting and settings	12
Answering a call	14
Making a call.....	14
During a call	14
Ending a call	15
Using a computer	16
General.....	16
Connecting via a sound card	16
Other connection options	20
Connecting a computer using a USB Adapter (accessory) .	20
Connecting a computer using Bluetooth (accessory).....	21
Connecting to a mobile or DECT telephone via a cable (accessory)	23
Extra microphones (accessory)	24
Troubleshooting	26
Connection	26
Sound	27
Technical data	28
Accessories, Service and guarantee	30
Order numbers for accessories.....	30
Service and guarantee.....	30

DESCRIPTION

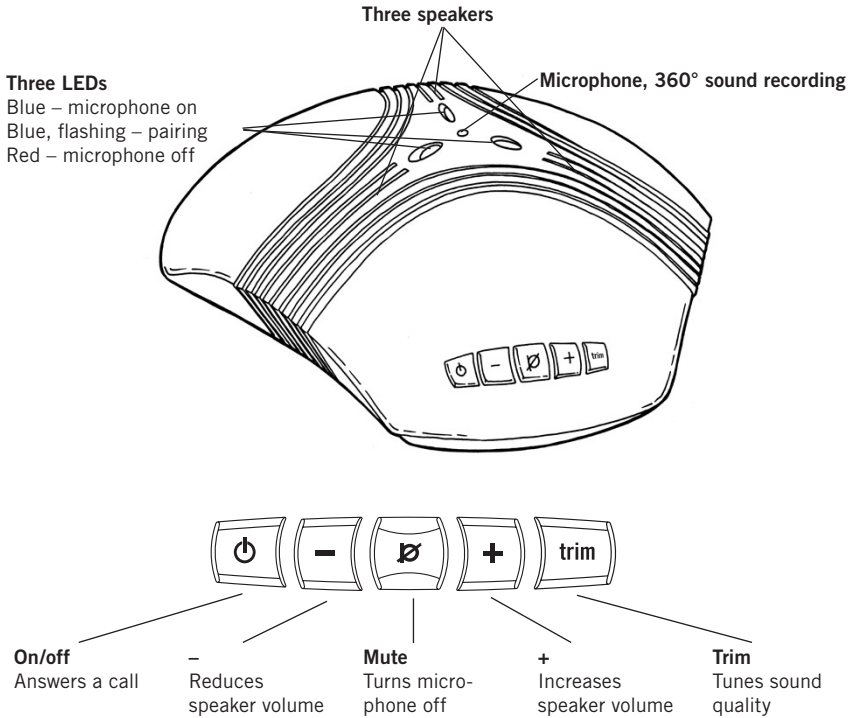

Konftel 60W is a conference unit for connecting to existing fixed system telephones, DECT telephones, mobile phones or computers, with a cable or wireless connection via Bluetooth. Konftel 60W has an omnidirectional, highly-sensitive microphone and three speakers which, together with Konftel's OmniSound® provide optimal sound quality and maximum reduction of room echo, even when the person speaking is standing at a slight distance from the unit.

Konftel 60W has five buttons. The most common functions for power, speaker volume and mute are obvious, but all the buttons have other functions for activating various special functions and settings. Therefore, you should read the sections of the handbook that deal with the connections you intend to use so that you do not miss any important options.

Plug adapter

Connection cable
electricity–mains
socket



Sockets for extra
microphones

Cable duct

Line connection

Power supply

Holes for
wall bracket

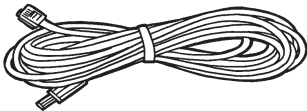
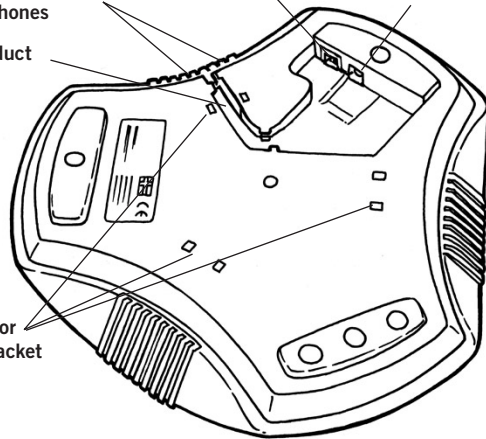

Connection cable
electricity,
6 m
(60W–plug adapter)

Switchbox

(60W–telephone headset)



Connection cable
telephone, 3 m
(60W–switchbox)

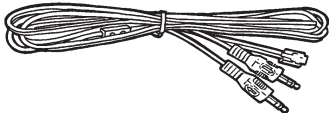

Connection cable
computer, 1.5 m
(60W–computer)

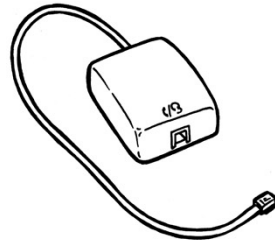

Konftel's website www.konftel.com offers suggestions for various applications and accessories for the 60W and other products.

Konftel 60W is designed to handle headset and handsfree profiles as per Bluetooth standard 1.1. Please note that not all telephones support all functions. More information is contained in your telephone handbook.

If the GSM network has reduced functionality, e.g. due to poor coverage, the sound quality may be affected. This is not due to the Konftel 60W.

MAINTENANCE

Clean the equipment with a soft, dry cloth. Never use liquids.

USING BLUETOOTH

Plug adapter

Only Helms-Man
DEN4824129, DPX481821
(USA) or DBN4824129
(UK) may be used

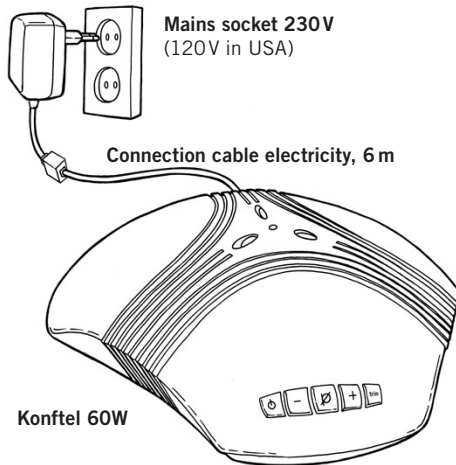

CONNECTING AND SETTINGS

⇒ Plug Konftel 60W in the mains using the power adapter as shown in the picture.

General information on Bluetooth

In order for two Bluetooth units to be able to communicate with each other, they must first be “paired”, which means that the second unit is added to a list of added units. Your Bluetooth telephone has a menu where added units are displayed and where you can, for instance, choose between various Bluetooth headset and handsfree options.

Familiarise yourself with your telephone’s functions by reading through this handbook. In the instructions below, we do not deal with how to use your telephone as this varies between various makes and models.

Please note!

The Bluetooth protocol, which is used by the units to communicate, has a number of commands to activate functions, end calls, etc. Some do not function fully on all telephones. You should therefore check, for instance, that the telephone has actually disconnected the call if you do this by pressing a button on Konftel 60W.

Bluetooth has a range of up to ten metres. The best performance is achieved when the distance does not exceed five metres.

Adding your telephone and retaining other stored telephones

Konftel 60W can store up to eight telephones. If you want to retain previous pairings and add a new one, follow the instructions below. If you want to remove a previous pairing, go to the next section.

If you store a ninth telephone, the telephone first stored is automatically deleted.

Please note that Konftel 60W should not be switched on when pairing.



⇒ Press and hold the **+** and **trim** buttons for 2 seconds until the blue LEDs start flashing.

⇒ Follow the instructions in your telephone handbook to add a new Bluetooth unit.

⇒ Select **Konftel 60W** from the list of units detected.

⇒ Enter the password **0000**.

If the pairing was successful, a short audible signal will be heard and the LEDs will stop flashing.

Please note that Konftel 60W is normally added as a *headset*. This will not work for certain telephones (Konftel 60W is not displayed as an available Bluetooth unit on the telephone). You can then choose instead to add Konftel 60W as a *handsfree* unit by pressing and holding the button for 4 seconds instead of 2 in the display. The blue LEDs then start flashing more slowly.

Adding your telephone and deleting other stored telephones

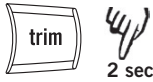

- ⇒ Press and hold the **trim** button for 2 seconds until the blue LEDs start flashing.
- ⇒ Follow the instructions in your telephone handbook to add a new Bluetooth unit to your telephone.
- ⇒ Select **Konftel 60W** in the list of units detected.
- ⇒ Enter the password **0000**.

If the pairing was successful, a short audible signal will be heard and the LEDs will stop flashing.

Removing all pairing information from Konftel 60W



- ⇒ Press and hold the – and + buttons at the same time for 2 seconds until you hear a short sound signal.

Adjusting the microphone volume

The microphone volume can be adjusted during a call, but to avoid disturbing the call, it may be best to adjust it during a test call after the telephone has been paired. The volume can be adjusted in 5 steps. Please note that different telephones may have different volumes and the microphone volume on Konftel 60W may need to be adjusted if you connect a different make of telephone.

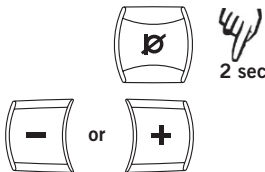

- ⇒ Press and hold the **mute** button for 2 seconds until the LEDs start to flash and you hear a tone.
- ⇒ Increase the microphone volume using the + button and reduce it using –.

Adjust the microphone volume one step at a time until you can hear well at the other end. Please note that too high a volume may cause echoes and feedback.



⇒ Press the **mute** button to conclude setting the selected microphone volume.

Changing the ringtone

The LEDs start flashing when there is an incoming call. You can also activate a ringtone in Konftel 60W.



⇒ Press and hold the – button for 2 seconds to activate the ringtone for incoming calls.

Follow the same procedure to deactivate it again.

ANSWERING A CALL



⇒ Press the **on/off** button when Konftel 60W rings (the LEDs flash).

The ring signal in the telephone may be heard before it is heard in Konftel 60W. Wait until Konftel 60W rings (the LEDs flash) before pressing the on/off button.

MAKING A CALL



⇒ Make a call with your telephone in the normal way.

⇒ Transfer the call to Konftel 60W as per the instructions in the telephone handbook.

If you have programmed Konftel 60W to function as a telephone headset, the call is normally transferred there automatically as long as the Bluetooth connection is activated.

DURING A CALL

Transferring a call between Konftel 60W and a telephone



⇒ Press and hold the **on/off** button for 2 seconds to transfer the call back to your telephone.

Adjusting the speaker volume

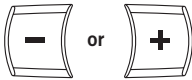

⇒ Increase the speaker volume using **+** and reduce it using **-**.

There are 15 volume settings. Please note that the telephone's volume setting also affects the speaker volume in Konftel 60W.

Mute function



⇒ Press the **mute** button to turn the microphone off.

The LEDs change from blue to red. The other party cannot hear what you are saying.



⇒ Press the **mute** button to turn the microphone back on.

Tuning the sound manually

Konftel 60W adjusts itself automatically when you switch it on to eliminate echo. It also senses changes in the room and continually adapts during the call. If, despite this, you still experience echoes, Konftel 60W can also be tuned manually at any time.



⇒ Press **trim**.

A short audible signal is heard.

ENDING A CALL



⇒ Ending the call on your telephone.

Konftel 60W switches off automatically. The call can also be ended by pressing **on/off**.

AFTER CALLS

Disconnecting the Bluetooth link

The Bluetooth link between the telephone and Konftel 60W is kept open until it is disconnected or until the units are out of range of each other. If you do not intend to use the phone for a while, you can choose to disconnect the link to save power.



⇒ Press the **mute** button to disconnect the Bluetooth link.

The link is automatically connected when the telephone rings or you make a call.

You can also disconnect Bluetooth using the mobile phone menu system. More information on this is contained in the telephone handbook.

Deactivating Bluetooth

If you choose to deactivate Bluetooth on Konftel 60W, all Bluetooth communication is turned off until you choose to re-activate it.



⇒ Press and hold the **on/off** and – buttons for 2 seconds to deactivate Bluetooth

⇒ Press and hold the **on/off** and – buttons for 2 seconds to activate Bluetooth again.

ADVANCED FUNCTIONS

These functions are only available if the telephone supports them.

Last number redial

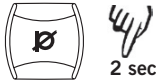

- ⇒ Press and hold the **mute** button for 2 seconds until you hear a short audible signal.

Making a call using voice command

This is a function you can normally activate on your telephone. If you have done this, you can also initiate voice dial mode from Konftel 60W. More information on voice dialling is contained in the telephone handbook.

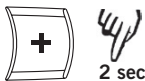

- ⇒ Press the **+** button for 2 seconds until you hear a short audible signal.
- ⇒ Say the name of the person you wish to call.

Answering another call

This requires you to have set the telephone to receive other calls during ongoing calls. You can also use the buttons on your telephone to answer another call.

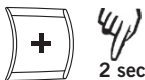

- ⇒ Press the **+** button for 2 seconds to put the current call on hold and receive the incoming one.

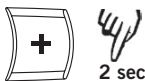

- ⇒ Select between the calls by pressing the **+** button for 2 seconds.

You can choose to end the current call and receive the incoming one (or the call on hold if you have already received a new call as above).

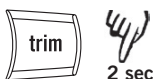

- ⇒ Press the **trim** button for 2 seconds to end the current call and receive the incoming one.

Multi-party calls

Once you have answered another call as per the previous section, you can add them to a multi-party call.



⇒ Press and hold the - and + buttons at the same time for 2 seconds.

Rejecting a call



⇒ Press and hold the **on/off** button for 2 seconds until you hear a short audible signal.

If you already have an active call, you can reject another incoming call in the same way.

USING A SYSTEM TELEPHONE

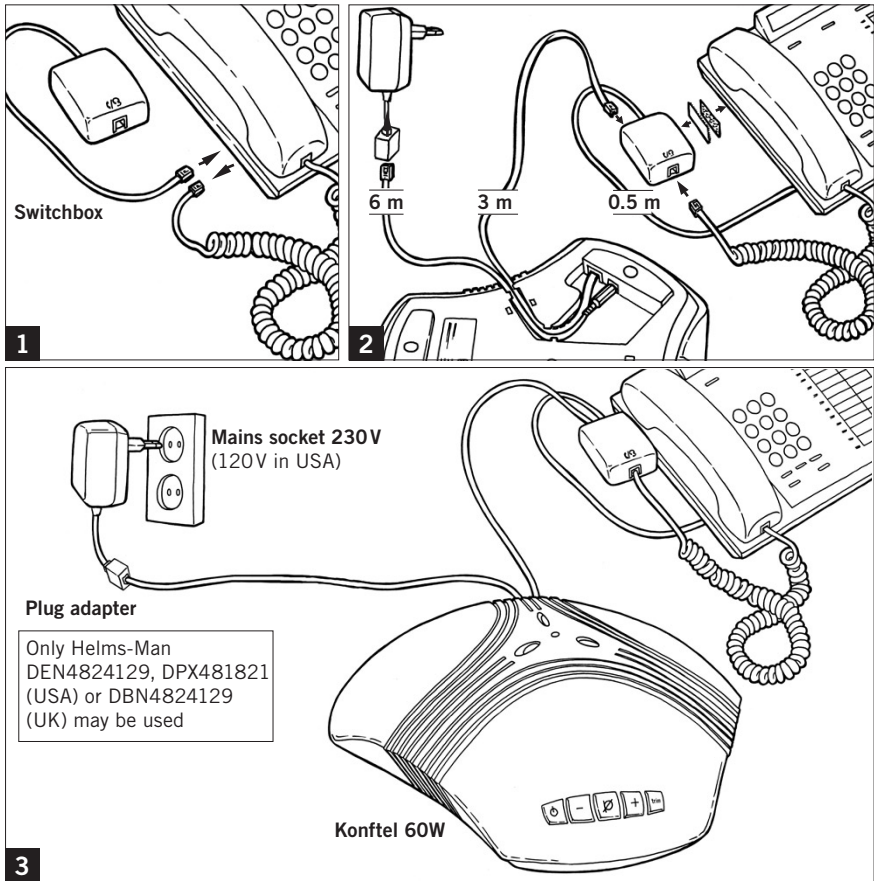

CONNECTING AND SETTINGS

- ⇒ Connect Konftel 60W to the telephone via the switchbox as per the pictures above.
- ⇒ Plug Konftel 60W in using the power adapter as shown in the picture.
- ⇒ Make a test call to check that everything works and to adjust the microphone setting.

Please note that the selector switch for different types of telephone is located on the bottom of the switchbox. See troubleshooting for more information if something does not work.

Using a headset instead of the handset

You can connect a headset to the switchbox instead of a handset. Please note that the headset must be suitable for the telephone system.

Adjusting the microphone volume

The microphone volume can be adjusted during the call, but to avoid disturbing the call, it may be best to adjust it during a test call following connection. There are 5 volume settings.

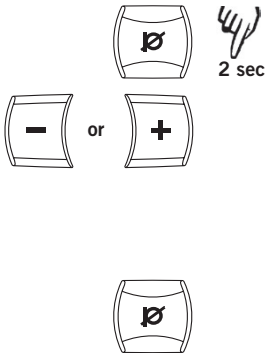

⇒ Press and hold the **mute** button for 2 seconds until the LEDs start to flash and you hear a tone.

⇒ Increase the microphone volume using the **+** and reduce it using **-**.

Adjust the microphone volume one level at a time until you can hear well in the other end. Please note that too high a level may cause echoes and feedback.

⇒ Press the **mute** button to conclude setting the selected microphone volume.

ANSWERING A CALL



- ⇒ Answer the call using the telephone in the normal way.
- ⇒ Press the **on/off** button to switch on Konftel 60W and change to speaker call.
- ⇒ Place the handset to one side – it is now disconnected.

MAKING A CALL



- ⇒ Lift the handset and dial the number.
- ⇒ Press the **on/off** button to switch on Konftel 60W and change to speaker call.
- ⇒ Place the handset to one side – it is now disconnected.

DURING A CALL

Transferring a call between Konftel 60W and a telephone



- ⇒ Press the **on/off** to switch off Konftel 60W and transfer the call back to the telephone.

Adjusting the speaker volume

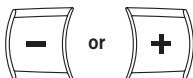

- ⇒ Increase the speaker volume using **+** and reduce it using **-**.

There are 15 volume settings. Please note that the telephone's volume setting also affects the speaker volume in Konftel 60W.



Mute function

⇒ Press the **mute** button to turn off the microphone.

The LEDs change from blue to red. The other party cannot hear what you are saying.



⇒ Press the **mute** button again to switch the microphone back on.

Tuning the sound manually

Konftel 60W adjusts itself automatically when you switch it on to eliminate echo. It also senses changes in the room and continually adapts during the call. If, despite this, you still experience reduced sound quality, Konftel 60W can be tuned manually at any time.



⇒ Press **trim**.

A short audible signal is heard.

ENDING A CALL



⇒ Hang up the handset.

⇒ Press the **on/off** button to turn off Konftel 60W.

USING A COMPUTER

GENERAL

Konftel 60W functions as a speaker and microphone for all computers that have a microphone input and a line output for sound. Konftel 60W can also be connected via a USB sound card or wirelessly via Bluetooth. The manner of connection may require accessories and is described in the section *Other connection options* on pages 20–21.

Use

You can use Konftel 60W for programs that communicate over the Internet (e.g. Skype). You make, answer and end calls in the program. Konftel 60W functions as a speaker and microphone when it is switched on.

The buttons for mute and manual tuning also function when connected to a computer (see page 15).

CONNECTING VIA A SOUND CARD

Connect in the order shown on the next page.

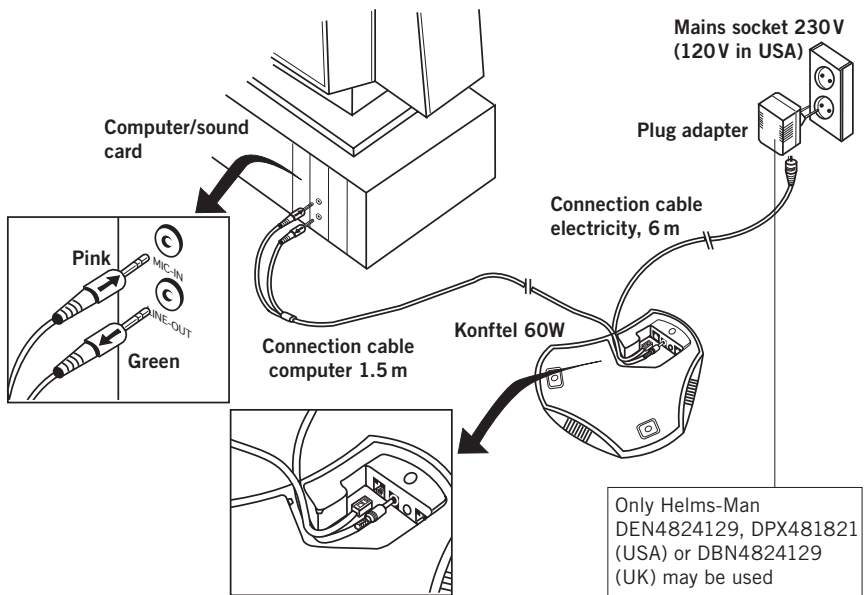

- ⇒ Connect Konftel 60W to the sound card using the accompanying Y-cable as per the picture.

LINE OUTPUT ----- OUT --- Green
MICROPHONE INPUT - IN ----- Pink

- ⇒ Plug Konftel 60W in using the power adapter as shown in the picture.



- ⇒ Start the computer and switch on Konftel 60W (the **on/off button**).

- ⇒ Check and adjust the computer's sound and volume settings as per the next section.

Checking the sound unit in Windows

There follows an example of how such items appear on a computer with Windows XP. Please note that it may look different on your computer. In a Macintosh you open the computer's system settings to select sound inputs and adjust sound levels.



- ⇒ Open **Properties** for **Sound and Audio Devices**. (Right click on the speaker symbol in the Activity field and select **Adjust Audio Properties** from the quick menu or use the start menu: **Start > Control panel > Sound and Audio Devices**.)

- ⇒ Click on the **Audio** tab and check that the computer's **sound card** is selected as the standard unit. Otherwise you must actively select the computer's sound card in your application (e.g. Skype®) each time you re-start the computer.

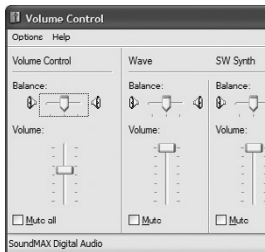

Adjust the speaker volume in Windows

- ⇒ Click on the **Volume...** button under **Sound playback** on the tab **Audio**.
- ⇒ Adjust the sound level for **Volume Control** so that it is between the intermediate and maximum level.

This setting adjusts the line output level from the computer. A low sound level here means that you must increase the volume on Konftel 60W to the maximum level, which may lead to fuzzy sound and a low sound level. A high sound level means that the volume on Konftel 60W can be set to an intermediate setting and still produce excellent sound through the speakers.

- ⇒ Check the sound level when you playback sounds (any sound source in the computer). Please note that Konftel 60W must be switched on.

Note that you also have separate volume controls for various sound sources in the computer. These volume controls apply to playback from each sound source. Choose **Mute** for microphone input if you do not want to hear your own voice through the speakers. A high volume may cause echoes and feedback.

Adjusting the speaker volume on Konftel 60W

If necessary, the volume on Konftel 60W can be adjusted during a call.

- ⇒ Increase the speaker volume using **+** and reduce it using **-**.

There are 15 volume settings.

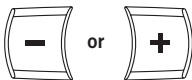

Adjusting the microphone volume in Windows



⇒ Click on the **Volume...** button under **Sound recording** on the tab **Audio**.

⇒ Adjust the microphone input between the intermediate and maximum level. Connect a call and adjust the volume if required.

It is best to use the communication program you intend to use with Konftel 60W when testing the microphone volume.

Adjusting the microphone volume on Konftel 60W

Adjust the microphone volume on Konftel 60W if required. There are 5 volume settings. Please note that Konftel 60W must be switched on.

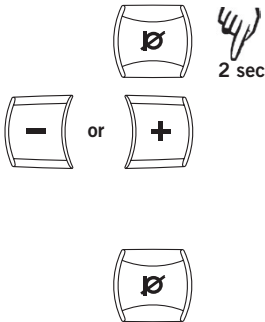

⇒ Press and hold the **mute** button for 2 seconds until the LEDs start to flash and you hear a tone.

⇒ Increase the microphone volume using **+** and reduce it using **-**.

Adjust the microphone volume one level at a time until the correct level is achieved.

⇒ Press the **mute** button to conclude setting the selected microphone volume.

OTHER CONNECTION OPTIONS

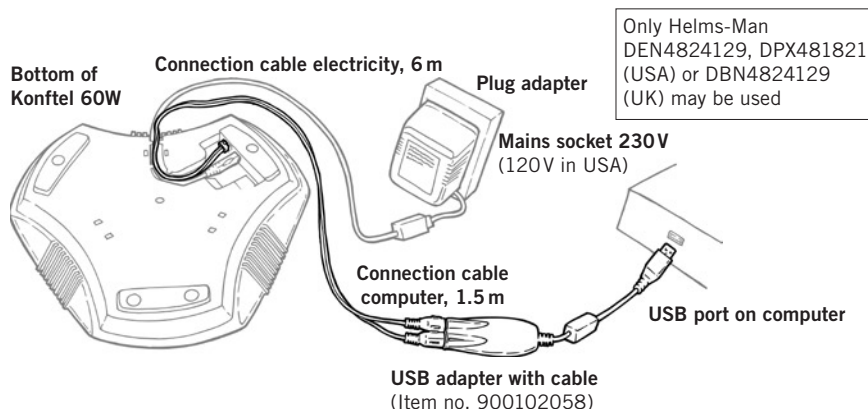

CONNECTING A COMPUTER USING A USB ADAPTER (ACCESSORY)

The USB adapter functions as a sound card in a computer without inputs and outputs for sound.

- ⇒ Connect the USB adapter to Konftel 60W as shown in the picture.
Green plug --Output labelled SPK on USB adapter
Pink plug ----Output labelled MIC on USB adapter
- ⇒ Connect the USB adapter to a USB port on the computer as shown in the picture.
- ⇒ Plug Konftel 60W in using the power adapter as shown in the picture.
- ⇒ Check the sound properties and adjust the sound volume in the same way as for a computer with built-in inputs and outputs for sound (see pages 17–19).

Please note that you must ensure that a **USB headset** is specified as the standard unit. Otherwise you must actively select USB headset as a sound unit in your application (e.g. Skype®) each time you re-start the computer.

Plug adapter

Only Helms-Man
DEN4824129, DPX481821
(USA) or DBN4824129
(UK) may be used

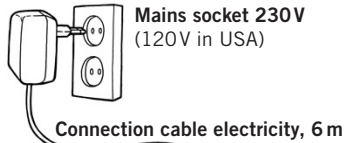

USB Bluetooth adapter
connected to a **USB**
port on the **computer**
(Item no. 900102072)

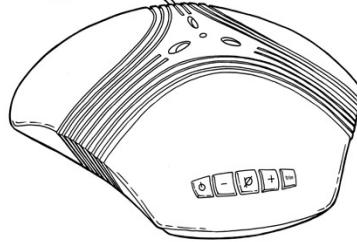

CONNECTING A COMPUTER USING BLUETOOTH (ACCESSORY)

If the computer has a built-in Bluetooth or is equipped with a USB Bluetooth adapter, it can be connected wirelessly to Konftel 60W provided it is within the range for Bluetooth.

Note that some computers and Bluetooth adapters do not support headset functions and are only intended for communication with mobile phones, hand-held computers, mice and keyboards. If possible, use Konftel's own adapter, sold as an accessory.

⇒ Plug Konftel 60W in using the power adapter as shown in the picture.

Pairing with a Bluetooth-equipped computer

Read the section “General information on Bluetooth” on page 4 if you are unsure about what pairing involves.

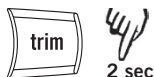

- ⇒ Press and hold the **trim** button for 2 seconds until you hear an audible signal and the blue LEDs start flashing.
- ⇒ Choose to search for new Bluetooth units in the Windows control panel.
- ⇒ Select **Konftel 60W** in the list of units detected.
- ⇒ Enter the password **0000**.

If the pairing was successful, a short audible signal will be heard and the LEDs will stop flashing. (Page 5 contains information on the handsfree and headset profile if pairing fails.)

Checking the sound properties in Windows

- ⇒ Check the sound properties and adjust the sound volume in the same way as for a computer with built-in inputs and outputs for sound (see pages 17–19).

Please note that you must ensure that **Bluetooth Audio** is specified as a standard unit. Otherwise you must actively select Bluetooth Audio as a sound unit in your application (e.g. Skype) each time you re-start the computer.

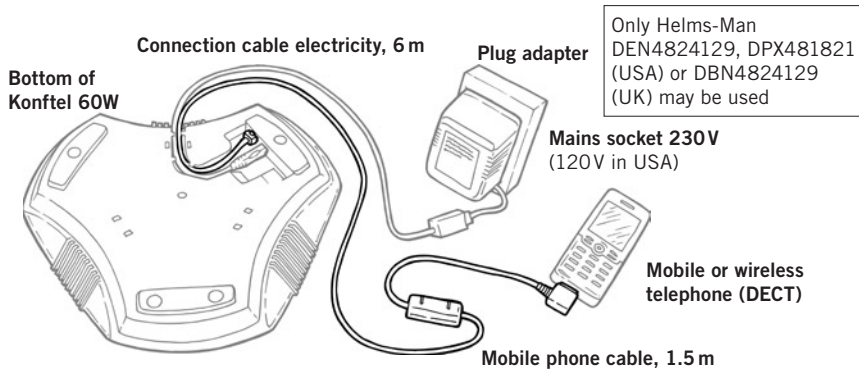

CONNECTING TO A MOBILE OR DECT TELEPHONE VIA A CABLE (ACCESSORY)

The Konftel 60W can be connected to a GSM or wireless DECT telephone using an accessory cable, as illustrated. Cables are available for most models on the market. Visit www.konftel.com for more information on accessories.

- ⇒ Plug Konftel 60W in using the power adapter as shown in the picture.
- ⇒ Connect the telephone to Konftel 60W as shown in the picture.
- ⇒ Adjust the microphone and speaker volume in the same way as when connecting to system telephones (see pages 13–14).

Use

See pages 15–16 for descriptions of how to make and answer calls and how the mute and tuning functions work.

EXTRA MICROPHONES (ACCESSORY)

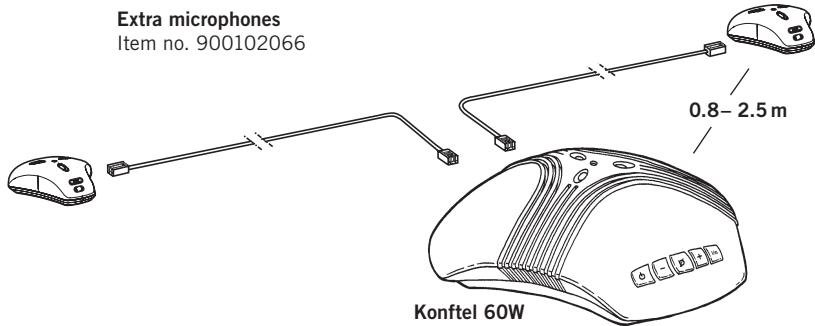

Connecting and settings

For a reception area up to 70 m², Konftel 60W can be quickly and simply supplemented with two extra microphones. The extra microphones are supplied with two different cable sets, 1.5 and 2.5 m.

⇒ Place the extra microphones at least 0.8 m and no more than 2.5 m from Konftel 60W and connect them using the accompanying cables.

A short audible signal specifies that the connection has been successfully established and that the software in Konftel 60W has been upgraded. The microphone in Konftel 60W is now disconnected.

Adjusting the speaker volume



⇒ Press the **up** or **down** button on one of the extra microphones to adjust the speaker volume.

Manual tuning



⇒ Press the **up** and **down** buttons at the same time for manual tuning (see page 8).

A short audible signal is heard.

Mute function



⇒ Press the **mute** button on one of the extra microphones to switch off the microphones.

The LEDs change from blue to red. The other party cannot hear what you are saying.



⇒ Press the **mute** button again to switch the microphones back on again.

TROUBLESHOOTING

A number of problems that may arise when connecting and using Konftel 60W are described below.

CONNECTION

Bluetooth

1. If Konftel 60W is not displayed when you try to add a new unit to the telephone, or if any particular Bluetooth function is not working, Konftel 60W may need to be presented as a handsfree unit instead of a headset. Repeat the instructions for “Adding your telephone” on page 5, except this time press and hold the **trim** button for 4 seconds instead of 2.

System telephone via switchbox

1. Is Konftel 60W correctly connected? See the instructions for connecting the telephone.
2. Have you added extension cords to the system? Remove them and re-connect to see if the system is working.
3. Check the position of the selector switch on the bottom of the switchbox. Select position **I** or **II** depending on which system telephone you are connecting Konftel 60W to.

Manufacturer	Type of switchboard	Selector switch position
ERICSSON	MD110	I
	BUSINESS PHONE	I
NORTEL	MERIDIAN 1	I
	COSMOS	I
PHILIPS	SOPHO	II
	ERGOLINE	I
ALCATEL	4200	I
	4400	I
SIEMENS	HIPATH	I
	HICOM	I

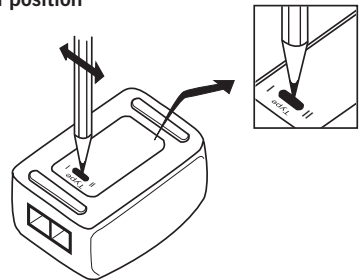

For other types of switchboard, try position I first, and then position II.

Computers

If a call can be heard via the computer's headset or built-in speaker, but not via Konftel 60W, check that the software and sound card can handle full duplex.

SOUND

No sound

1. Are the LEDs red? If so, the mute button is activated. Press to deactivate.

Poor sound quality, echo

1. Check that Konftel 60W is within the range for the telephone.
2. Check the position. The unit is intended to stand flat on a table. Avoid moving the unit around during a call. Do not place the unit too close to a wall or underneath objects such as lampshades or pot plants.
3. Tune Konftel 60W manually. See instructions for manual tuning.
4. Is the volume correctly adjusted? See the instructions for adjusting the volume setting for the microphone.
5. Is the other party using a conference unit, sound card or software that cannot handle full duplex?

TECHNICAL DATA

Konftel 60W

Power supply:	Transformer 12 V DC/230V AC, 700 mA (Europe) Transformer 12 V DC/120V AC, 700 mA (USA)
Inputs:	Analogue line in/out, modular 6/6 Rec (speaker) -10 dBV (adjustable) Broadcast (microphone) -30 dBV (adjustable)
Speaker volume:	Adjusts to 15 levels
Microphone volume:	Adjusts to 5 levels
Room echo reduction:	208 ms
Line echo reduction:	38 ms
Environment:	Reception area <30 m ² Reverberation time in room <500 ms Background noise <45 dBA Temperature range: 0–40° C
Electrical safety:	UL60950-1 CAN/CSA C22.2 No. 60950 EN60950
RF/EMC:	ETSI EN301489-17 V1.2.1 FCC Part 15 Certificate RSS210 ETSI EN300 328-2 V1.2.1
Telecom:	FCC Part 68 Registration IC CS-03
Dimensions:	Diameter 232 mm
Weight:	700 grams

Switchbox

Input telephone handset:	modular 4/4
Input Konftel 60W:	Cable, modular 6/6
Output telephone:	Cable, modular 4/4. The contact for connecting a switchbox to a system telephone may only be connected to SELV current in accordance with SS-EN60950
Compatibility:	Can be connected to most system telephones on the market

Computer cable

Y-cable: 1 x modular 6/4, 2 x Tele 3.5 mm. Contact for connecting a Konftel 60W to a computer may only be connected to SELV current in accordance with SS-EN60950

Extra microphones (accessory)

Cabling: Modular 4/4-contacts, 2x1.5 m and 2x2.5 m
Environment: Temperature range: 0–40° C
Dimensions: Diameter 105 mm, height 30 mm

USB adapter for sound (accessory)

USB connection: USB 1.1 Full-speed
System req. PC: Pentium >200MHz, min 256 MB RAM, spare USB port

USB Bluetooth adapter (accessory)

Bluetooth connection: 1.2 class 1 and class 2
USB connection: USB 1.1 Full-speed
System req. PC: Pentium >200MHz, min 256 MB RAM, spare USB port
Dimensions (LxWxH): 50x17x10 mm

ORDER NUMBERS FOR ACCESSORIES

Item no.	Designation
9146030	Wall mounting bracket
9164032	Extension cord electrical, 10 m
900102038	Extension cord telephone, 10 m
900102058	USB adapter for sound
900102066	Extra microphones (1 pair)
900102067	Soft bag
900102072	USB Bluetooth adapter
	Connection cables GSM/DECT see www.konftel.com , under Accessories Konftel 60W

SERVICE AND GUARANTEE

In the first instance contact your Konftel retailer if your conference telephone needs servicing.

See the American User Guide for guarantee terms and information on American FCC and Canadian IC norms. Contact Konftel support for more information.

KONFTEL support

+46(0)90-706 489 (Monday-Friday 08.00–17.00)

E-mail: info@konftel.com

USA and Canada:

+1-(847)-981-9305 (Monday-Friday 08.00–17.00)

E-mail: konftel.usa@konftel.com

Konftel is a leading company within loudspeaker communication and audio technology. We develop and sell products and technology for telephone meetings based on cutting-edge expertise within acoustics and digital signal processing. Characteristic of our products is that all conference telephones contain the same high quality audio technology – OmniSound® – providing crystal clear sound. Learn more about Konftel and our other products on **www.konftel.com**

Developed by Konftel AB
Box 268, SE-901 06 Umeå, Sweden
Phone: +46 90 706 489 Fax: +46 90 131 435
E-mail: info@konftel.com Web: www.konftel.com
