

User guide

Conference phone Konftel 200/NI

Deutsch | English | Français | Italiano

Intelligent communications



This package includes the following items:

- 1 pc User Guide
- 1 pc Conference phone
- 1 pc Mains transformer
- 1 pc Power supply and POTS network cable
- 1 pc Power supply and ISDN network cable
- 1 set Intermediate plugs

The optional equipment package includes the following items:

- 1 pair Extra microphones
- 2 pcs Extra microphone cable 1.5 m (4.9 ft)
- 2 pcs Extra microphone cable 2.5 m (8.2 ft)
- 1 pc Remote control
- 4 pcs Batteries for the remote control

**Please check that the package contains all items listed.
If any items are missing, please contact your dealer.**

Contents

Arrangements	4
Description	5
Connections	6
Settings	7
<i>Network setup after power on</i>	7
<i>Manual network selection</i>	7
Video line sharing	8
<i>Connection</i>	8
<i>Own MSN number</i>	9
Volume control, mute, tuning	10
Calls	11
Three-party calls	12
Programming the R key	13
Speed dialling, redial	14
Menu	15
<i>Add a new number in Phonebook</i>	15
<i>Edit Phonebook</i>	16
<i>Delete Name and Number</i>	17
<i>Adjust the Ring Signal Volume</i>	17
<i>Change Time and Date</i>	18
<i>Select Language</i>	18
<i>Keypad tone</i>	19
Accessories	20
<i>Remote control</i>	20
<i>Remote control functions</i>	21
<i>Extra microphones</i>	22
<i>Accessories and spare parts</i>	23
Troubleshooting and maintenance	24
Technical data	25
Display and keyset	27

For optimum sound reproduction, position the units as shown in the illustrations

Use Konftel 200/NI for room size up to 30 m² (323 sq ft)

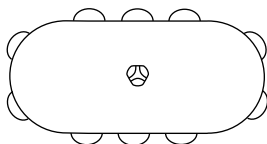
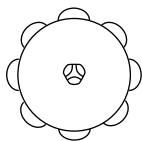

Use Konftel 200/NI with extra microphones for room size up to 70 m² (753 sq ft)

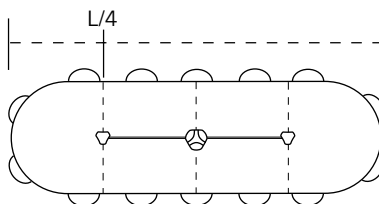
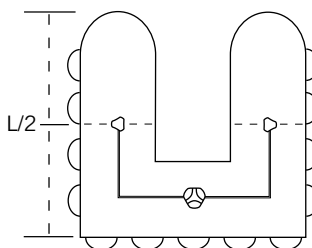
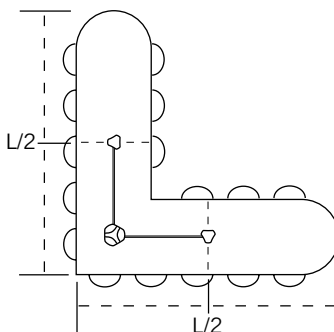

Top

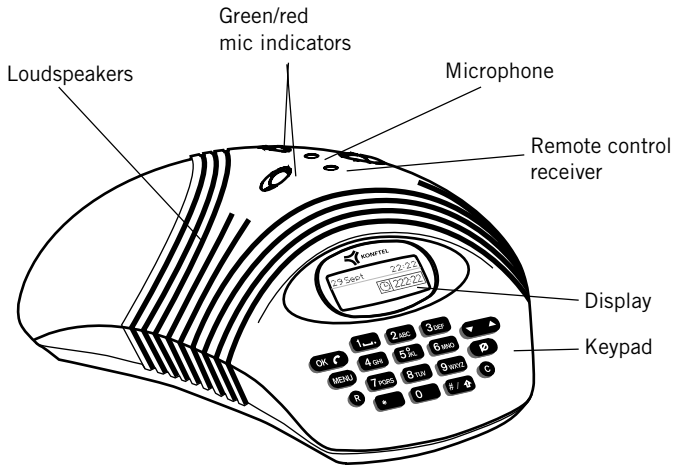

Bottom

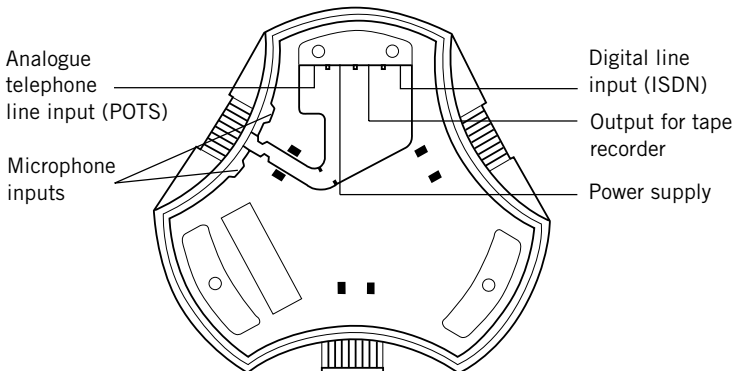

An overview of the Konftel 200/NI's keypad is shown on page 27.

Analogue (POTS)

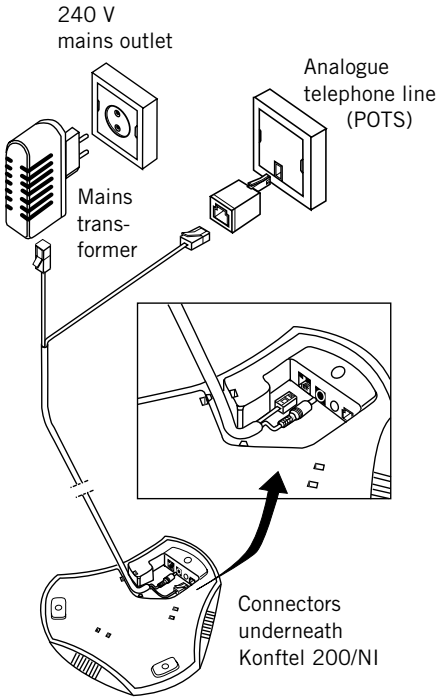

Digital (ISDN S₀)

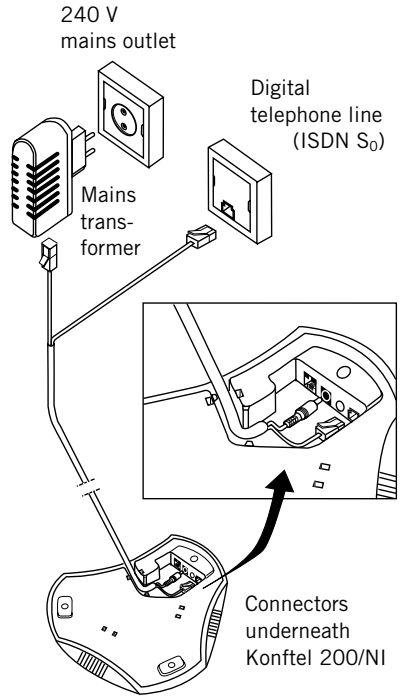

Only a mains transformer of the FRIWO type FW7237/12 or the Perfekt 2042 and 2043 type may be connected.

Network set-up after power on (default: Auto)

Connect Konftel 200/NI to the power socket outlet. Choose Auto for automatic search. Konftel 200/NI searches automatically for an ISDN S₀ line.

Certain ISDN S₀ lines will not be found automatically by the telephone, even though it is connected to such a line. If this happens, the line must be chosen manually; see below.

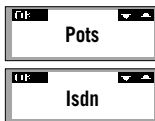

If not connected to a digital line, please use the Up/Down key to select ISDN (digital) or POTS (analogue). This setting will not be saved for the next time the telephone is powered-up.



Press OK to confirm.

Manual network selection (default: Auto)

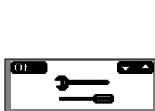

Press Menu.

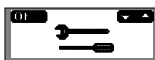

Select Settings menu.



Select Net.



Select either digital line connection (ISDN), analogue line connection (POTS) or Auto mode for automatic searching. This setting will be saved for the next time the telephone is powered-up.



Press OK to confirm

8 Video line sharing

Connection



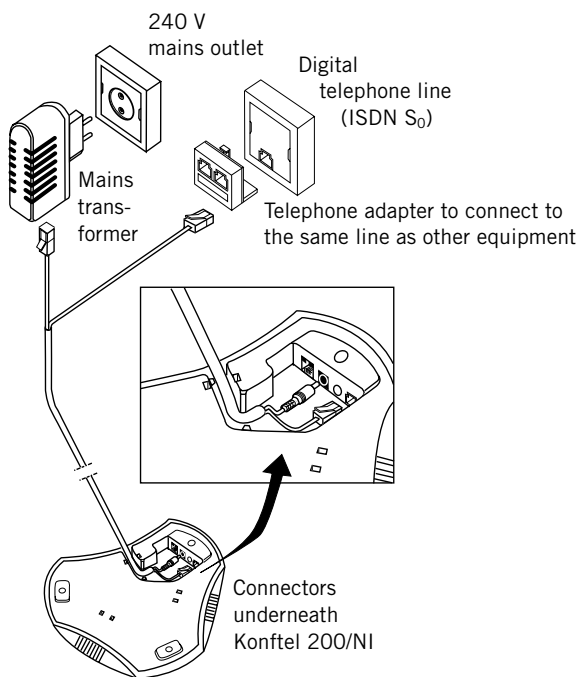









With Konftel 200/NI it is possible to share an ISDN S_0 line with any other ISDN device e.g. video conferencing equipment or a modem. Just enter a unique MSN number (multiple subscriber number) as your own number. The MSN-number separates a Telemeeting from a video conference, for example



Only a mains transformer of the FRIWO type FW7237/12 or the Perfekt 2042 and 2043 type may be connected.

Note: Konftel cannot guarantee full functionality of the equipment which shares an ISDN line with the Konftel 200/NI. Please contact your reseller if you have any questions on this subject.

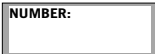
Own MSN-number (default: none)

- | | | |
|---|---|--|
| |  | Press Menu. |
|  |  | Select Special Settings menu. |
| |  | Press OK. |
|  |  | Choose Own number menu. |
| |  | Press OK. |
|  | <i>0-9...</i> | Enter your telephone number (MSN number). |
| |  | Press OK to save. |
| |  | Press the C key to return to the starting position. |
| | | Note: The own MSN number feature only works when connected to an ISDN line. If an own number has been programmed in, the Konftel 200/NI will only respond to incoming calls to that number. If no own number has been programmed in, the Konftel 200/NI will respond to all incoming calls, regardless of the number. |
|  |  | An own number can be deleted using the C key in the Own number menu. |

Volume control

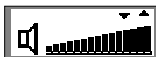

Adjust the speaker volume with the Up/Down key during the call.

Mute function

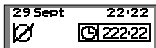

Press the Mute key to switch off the microphone. The mic indicators change to red. Press again to switch on the microphone. The mic indicators change back to green.

Tuning



The sound is adjusted automatically for the room and the telephone line when Konftel 200/NI is switched on. Konftel 200/NI senses the acoustics of the room and adapts continuously during the call. For manual tuning, press the Up/Down key at the same time. A brief noise will be heard.

Incoming calls



(POTS) A ring signal is heard and the green mic indicators light to indicate the incoming call.



(ISDN) A ring signal is heard and the green mic indicators light to indicate the incoming call. The incoming call number ID is shown in the display.



Press the OK key to answer.



The call duration is displayed in the call meter display.



To end the call, press OK.

Outgoing calls



Press OK.

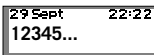

0-9...

Dial the number.

or

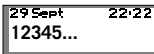

0-9...

To preview, first enter the phone number.



Press OK. The number is called within 3 sec.



The call duration is displayed in the call meter display.



To end the call, press OK.

Three-party calls

29 Sept 22:22
1234567

Enter the number of the first meeting participant.



Press OK. The number is called within 3 sec.



When the first call is connected, press the R key to get a new dial tone.

29 Sept 22:22
1234567

Enter the number of the second meeting participant and wait for answer.



Press the R key followed by the 3 key, and all three can now participate in the call.

If your call is not answered



Press the R key followed by the 1 key to return to the first call.

Note: The availability and function of the three-party feature can vary from country to country but also depend on the PBX to which the Konftel 200/NI is connected. If you want to connect multiple participants we recommend you use a telephone meeting service. If you have questions regarding availability, please contact your dealer.

If the R key does not work (POTS)

The requirements for the operation of the R key vary between PBXs and from country to country. Konftel 200/NI therefore lets you program the R-pulse time so that it works with most PBXs on the market.

Programming the R key (default setting = 2)



Press Menu.



Select Special Settings menu.



Press OK.

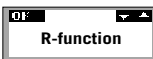

Choose R-function.



Press OK.

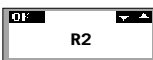

Enter the value for the R-pulse. The default setting is 2. Check in the table below whether the setting is right for your PBX/country.

Value:	Time:	PBX/country:
R1	65 ms	Ericsson MD110
R2	100 ms	Scandinavia, Europe
R3	150 ms	Reserved
R4	270 ms	Germany, France, Israel
R5	600 ms	USA



Press the OK key to save the settings and exit.

Retrieve speed dial numbers



Press the Up/Down key to scroll/view the Phonebook in alphabetical order. The last number dialled will appear first in the list.



Press OK to dial the selected number. The number is displayed and dialled within 3 sec.



To end the call, press OK.

Redial

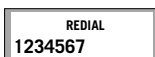

Press the Up key. The last number dialled will appear in the display.





















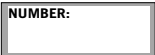
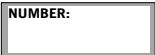

Press OK to dial the number. The number is dialled within 3 sec.



To end the call, press OK.

Add a new number in Phonebook

-   Press Menu.
-   Select Phonebook menu.
-   Press OK.
-   Select Add entry.
-   Press OK. The last number dialled will appear automatically.
-  **0-9...** Enter a telephone number with the keypad.
-   Press OK.
-  **A-Z...** Enter a name with the keypad. Press the key until the desired letter appears in the display and then enter the next letter. (A description of the characters that can be used is found on page 27.)
-   Press OK. The number and name are now stored. "Memory full" appears in the display if you attempt to save more than 50 numbers.
-   Press the Shift key to write small letters.
-   Press the C key to delete a number or letter.
-   Press the Menu key to cancel.

Edit Phonebook



Press Menu.



Select Phonebook menu.



Press OK.



Select Edit.



Press OK.



Select the name you want to edit from the list using the Up/Down key.



Press OK.

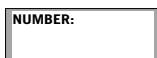

0-9...

Edit the number with the keypad and press OK.

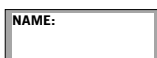

A-Z...

Edit the name with the keypad and press OK.



The number/name is now stored.















Press the C key to delete a number or letter.



Press the Menu key to cancel.

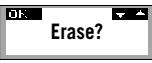











Delete Name and Number

-  Press Menu.
-   Select Phonebook menu.
-  Press OK.
-   Select Erase.
-  Press OK.
-   Select the name that you wish to delete from the list.
-  Press OK to select.
-  "Erase?" appears in the display.
-  If you do not wish to delete, press the C key.
-  If you wish to delete, press OK. The selected name and number are now deleted.

Adjust the Ring Signal Volume

-  Press Menu.
-   Select the Ring Signal Volume menu.
-  Press OK.
-   Adjust the volume with the Up/Down key. The ring signal is switched off by selecting the symbol with an oblique bar over the bell.
-  Press OK. The Ring Signal Volume is now stored.









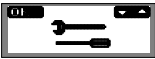

Change Time and Date

-  Press Menu.
-   Select Time and Date menu.
-  Press OK.
-   Adjust Time and Date with the Up/Down key.
-  Select Date. Press OK.
 Select Month. Press OK.
 Select Year. Press OK.
 Select Hour. Press OK.
 Select Minutes. Press OK.
 Time and date are now stored.
-  Go back with C key

Select Language

-  Press Menu.
-   Select Language menu.
-  Press OK.
-   Select language with the Up/Down key.
-   Select language with the Up/Down key.
- ...
-  Press OK.

Keypad Tone (default on)

-  Press Menu.
-   Select Special Settings menu.
-  Press OK.
-   Select Keypad tone.
-  Press OK.
-   Select Keypad tone On/Off using the Up/Down key.
-   Press OK.

Note! When dialling, the touch tones will always be heard even if the keypad tone is switched off.





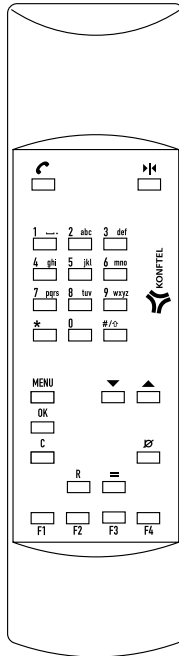

Remote control

Item No.
900102038



Konftel 200/NI can be supplemented with a remote control. All functions can then be operated from your position, regardless of where you are standing or sitting.

Remote control functions

	<input type="text"/>	Lifts and replaces the "handset" regardless of whether Konftel 200/NI is in menu mode. If the Phonebook is displayed, the number shown will be called.
1 	9 	
<input type="text"/>	— <input type="text"/>	Enter the number or write the name. #/△ shifts between capitals and small letters.
MENU	<input type="text"/>	Enters and exits menu mode.
OK	<input type="text"/>	OK in menus, lifts and replaces the "handset". Dials the speed dial number.
C	<input type="text"/>	Deletes characters when dialling numbers or writing names. Exits from menus.
R	<input type="text"/>	Used for operator services, e.g. for three-party calls.
F1	— F4	
<input type="text"/>	<input type="text"/>	When a speed dial number is saved in the Phonebook or edited, it may be stored by ending the programming with a function key instead of OK. The number behind the key is called in all menu modes other than programming. NOTE: A function key is overwritten without prior warning when a new number is stored.
	<input type="text"/>	Tunes the Konftel 200/NI to the acoustic environment of the room.
		
<input type="text"/>	<input type="text"/>	Adjusts the volume, leafs through the Phonebook and scrolls through the menus.
	<input type="text"/>	Mute function. Switches the microphones on and off. Inserts a pause in speed dial numbers.
=	<input type="text"/>	Calls the last number dialled regardless of the menu mode.

Extra microphones

Item No.
900102041

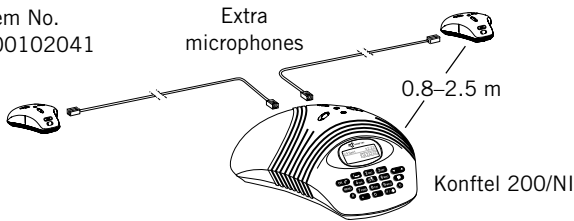

For larger rooms, Konftel 200/NI can be supplemented quickly and simply with two extra microphones. It is then able to provide coverage of up to 70 m².

Advantages: stronger sound from the speakers, higher microphone sensitivity.

The extra microphones are placed not less than 0.8 m and not more than 2.5 m from the central unit and are connected using the cables supplied **before** making the call.



Once they are connected, the built-in microphone of the Konftel 200/NI is disconnected and the display shows how many units are connected.

The extra microphones are supplied with two sets of cable, 1.5 m and 2.5 m. It may prove difficult to detach the cables when disconnecting the extra microphones, and this may be facilitated by the careful use of a screwdriver or ballpoint pen, for example.



The speaker volume can also be adjusted from the extra microphones. Tuning can also be performed from the extra microphones. Press the Up/Down key at the same time. A brief noise will be heard.



Press the Mute key for muting. Muting affects all the connected microphones. The microphone indicators will change from green to red.

Item No.	Description
900102041	Extra microphones
900102038	Remote control
9146030	Wall mounting bracket
900103342	Tape recorder cable
900103339	Extension cable, power supply 10 m
900103340	Extension cable, analogue network, 10 m
900103353	Extension cable, digital network, 10 m
900103341	Extension cable, power and analogue network 7.5 m
900103352	Extension cable, power and digital network 7.5 m

Intermediate plugs

Item No.	Description
208102012	Denmark
246102012	Finland
250102012	France
276102012	Germany
826102012	Great Britain
528102012	Netherlands
578102012	Norway
724102012	Spain
752102012	Sweden
756102012	Switzerland

Spare parts

Item No.	Description
900103334	Power supply and analogue POTS network cable, 7.5 m
900103349	Power supply and digital ISDN network cable, 7.5 m
900102026	Mains transformer 12 V DC, Europe
826102026	Mains transformer 12 V DC, UK

Troubleshooting

1. Check that the microphone is on during the call. The green microphone indicators must be lit.

2. Check that Konftel 200/NI is connected.

Connection to an analogue line: check that the POTS network cable is connected between the POTS input and an analogue jack.

Connection to an ISDN S₀ line: check that the ISDN network cable is connected between the ISDN input and an ISDN S₀ line.

3. Bypass any extension cables and check whether the system is functioning correctly. If not, contact your dealer.

4. Disconnect the extra microphones and see if the system works without them. If not, return all units for service.



5. If Konftel 200/NI must wait for a second dial tone, you should insert a pause with the Mute/ Pause key when entering telephone numbers in the Phonebook.

Maintenance

Clean the equipment with a dry, soft cleaning cloth. Do not use any liquids!

Central Unit

Power supply:	DC transformer 240 V AC/12 V DC; 700 mA.
Network interface:	Analogue POTS, RJ-11. Digital ISDN S ₀ , RJ-45.
Power supply and POTS network cable:	7.5 metre, RJ-11 (line), EIAJ Class IV (power).
Power supply and ISDN network cable:	7.5 metre, RJ-45 (ISDN), EIAJ Class IV (power).
Recommended room conditions:	Reverberation time: <0.5 sec. Background noise: <45 dB(A).
Frequency response:	200 – 3700 Hz.
Loudspeaker volume:	85 dB SPL (increased if extra microphones are used).
Room echo suppression:	208 ms.
Line echo suppression:	25 ms.
Automatic calibration:	<1 ms impulse (not discernible).
Tape recorder output:	3.5 mm tele jack. Contact for connection of tape recorder may only be connected to a SELV voltage in accordance with SS-EN 60 950.
Dimensions:	Diameter 232 mm.
Weight:	800 g.
Temperature range:	5 – 40° C in operation.
Humidity:	20 % – 80 % non-condensing.
EMC:	EN 50 081-1:1992. EN 50 082-1:1992. EN 61 000-4-2:1995.
Electrical safety:	EN 60950.
Telecom approval POTS:	EUROPEAN CTR21.
Telecom approval ISDN:	EUROPEAN CTR3.
Keyboard:	19 keys.
Compatibility:	Konftel 200/NI can be connected to any PBX equipped with ISDN S ₀ or POTS extension, for example Ericsson: MD110, Fenix. Siemens: Hicom. Nortel: Meridan. Philips: Sopho. Alcatel: 4200, 4400. Ascom: Ascotel. Tenovis: Intergral 3, 33.

Extra microphones (accessories)

Power supply:	Power from microphone outlet
Cabling:	Modular 4/4 contacts 2 x 1.5 m and 2 x 2.5 m
Microphone:	Omnidirectional
Microphone indicator:	Green – microphone on Red – microphone off
Temperature range:	5 – 40° C in operation
Keyboard:	3 keys

Remote control (accessories)

Batteries:	4 x R03, 1.5 V
Temperature range:	5 – 40° C
Range:	Up to 5 m
Dimensions:	205 x 55 x 21 mm (L x B x H)
Weight:	140 g
Keyboard:	26 keys

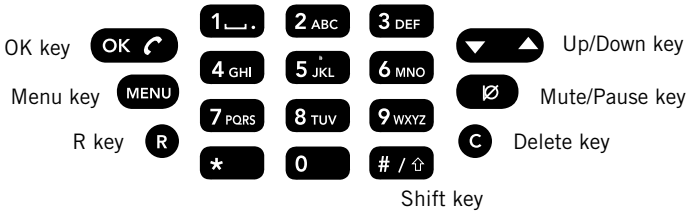
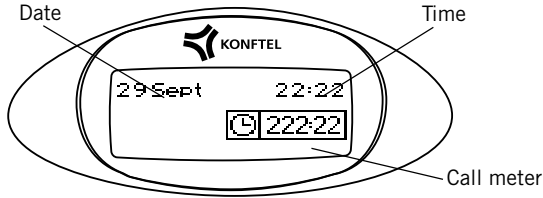

1 .	1, space, . (period)	7 PQRS	7, P, Q, R, S, p, q, r, s
2 ABC	2, A, B, C, Ä, Å, Á, À, a, b, c, ä, å, á, à	8 TUV	8, T, U, V, Ü, Ú, t, u, v, ü, ú
3 DEF	3, D, E, F, É, È, d, e, f, é, è	9 WXYZ	9, W, X, Y, Z, w, x, y, z
4 GHI	4, G, H, I, g, h, i	0	0
5 JKL	5, J, K, L, j, k, l	*	*
6 MNO	6, M, N, O, Ö, Ø, Ñ, m, n, o, ö, ø, ñ	#	#

Konftel Technology was one of the first companies in the world to develop advanced conference phones with Full Duplex-technology. Today we are the world leaders in loudspeaking communications and we also develop the technology for implementation in both our own and other companies' hands-free products. Read more about Konftel Technology, the intelligent sound technology, and our other products on **www.konfteltech.com**

Developed by Konftel Technology AB – a Konftel Group company
Box 268, SE-901 06 Umeå, Sweden
Phone: +46 (0)90 706 489 Fax: +46 (0)90 131 435
E-mail: konfteltech@konftel.com Web: www.konfteltech.com
